



# Eurolight



# In safe hands

Since 1958, people have put their trust in our trailers, just ask an owner - they're not difficult to find. As specialists in trailer design and engineering, we have continued to set the standard both in the UK and throughout much of Europe. We are an independent company with one focus: to build the best products on the market. More than 30,000 people choose our trailers each year - but we're not standing still. Our dedicated investment in new technologies and materials ensures that our products continue to exceed the expectations of our customers. We know that quality, strength, value and ease of maintenance are of vital importance to you. That's why we've made them the driving force behind everything we do.



# Ifor Williams Eurolight

Introducing our latest trailer range, **The Eurolight**, designed for the commercial and domestic user running small commercial vehicles or cars.

Offering a choice of eleven multi purpose trailers, the Eurolight range has been designed for versatility. With a maximum gross weight of between 1000kg and 2000kg, there is sure to be a trailer in the range to suit your requirements.

## Tow in style

The Eurolight range incorporates all of the high standards expected from Ifor Williams Trailers, whilst at the same time introducing aesthetic changes to produce a stylish trailer that remains in-keeping with the distinctive Ifor Williams design.

## Stability when towing

Also featured in the range is the exclusive Ifor Williams beam axle and leaf spring suspension system, developed and refined for a safe and stable ride. Renowned for its durability and ease of maintenance, the Ifor Williams beam axle system contributes significantly to the low depreciation of all our trailer models.

## Safety when moving

To ensure your load is restrained securely and safely whilst travelling, Eurolight trailers are offered with various load restraint options, which can give extra security for any non-standard loads.

## Minimal upkeep - built to last

The galvanized steel chassis and drawbars offer unbeatable corrosion protection. All trailers are security marked and every detail is specified for top performance and a long, trouble-free life.

# Ifor Williams Eurolight



**The Eurolight range offers practical and stylish multi-purpose trailers that maintain their durability, robustness and ease of towing, synonymous with the Ifor Williams brand.**

Ideal for both the domestic and professional user, the Eurolight offers lighter alternatives to traditional Ifor Williams Trailers and is suitable for lighter commercial vehicles and cars with lower towing weight capacities. From horse owners to landscape gardeners, the Eurolight range has been designed for various jobs for the domestic and business user.

#### **Standard Features:**

The Eurolight multi-purpose range is offered in 2 width options, 1.3m and 1.58m and 4 length options from 2.08m to 3.68m. Single and tandem axle options are available. Maximum gross weights of the Eurolight models range from 1000kg to 2000kg.



EL101-2012



EL101-2012 with optional aluminium easylatch dropsides, tailboard & headboard

# Eurolight Unique Features



EL142-3615



EL142-3615 with optional steel drop sides, tailboard & headboard

Our latest trailer range offers exceptionally lightweight trailers without compromising strength or durability. The combination of engineering design and high strength materials has produced a trailer range with an excellent strength to weight ratio. Unladen weights of the trailers start from only 225kg with the largest 3.68m trailer being only 403kg. Having undergone rigorous testing on our fatigue testing rig, Eurolight trailers will meet the needs of even the most demanding user.

## Optional Unique Features

The Eurolight range boasts features not seen on any previous Ifor Williams multi-purpose trailers, resulting in a distinctive and stylish look:

- Aluminium dropsides with easylatch feature and integrated safety mechanism for speed and simplicity.
- Colour co-ordinated corner posts and end caps.
- Loading skids for side and rear attachment - useful for unloading awkward loads.
- Rear skid storage system.

Eurolight trailers can also be purchased with hinged steel dropsides and / or ladder rack.



To release the dropsides simply apply slight inward pressure to the dropside then lift the latch with fingers to release. The dropsides will only release when pressed inwards prior to the latch being lifted (Lifting the latch alone will not release the dropside).

# Eurolight Standard Features

It's the attention to detail of Ifor Williams trailers that makes our products so popular with owners. Just take a look at these standard features.

## Chassis

The underside of the trailer features a galvanized steel chassis and drawbar, for long-lasting corrosion protection.



## Floor

Resin coated on both sides, our ply platform floors feature an embossed grip pattern on the upper surface.

## Beam axle & leaf spring suspension

The Ifor Williams beam axle system increases stability and reliability whilst ensuring minimum maintenance.

## Spare wheel

A mounting bracket and spare wheel are fitted as standard to all Ifor Williams trailers for complete peace of mind.

## Adjustable coupling height

All trailers are fitted with spacers under the coupling body. When removed, the towing height can be lowered by up to 40mm (25mm on model EL141-2515).



The lockable coupling head can be locked on or off the tow ball for additional security (Padlock not included).

# Eurolight Options



## Aluminium Dropsides

Removable aluminium easylatch dropsides, tailboard & headboard.



## Steel Dropsides

Traditional alternative.



## Aluminium Headboard

Fixed.



## Steel Headboard

Removable headboard, particularly useful for transporting longer loads.



## Floor Covering

Aluminium treadplate.



## Perforated Steel Loading Skids

2.00m long with hook locking feature. Can be used on all trailer sides. A skid carrier may be purchased to store skids within the trailer chassis.



## Lashing Rings

Recessed hinged ring providing a secure floor level fixing point.



## Removable Ladder Rack

Only available with a headboard.

# Eurolight Specifications

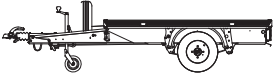
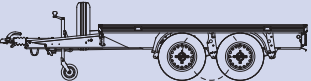
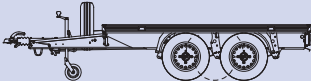
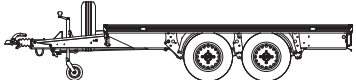
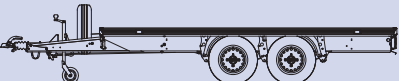
	1.30m width	1.58m width
2.08m length	EL101-2012 	
2.58m length	EL101-2512 EL142-2512 	EL101-2515 EL141-2515 EX202-2515 EL142-2515 
3.08m length		EX202-3015 EL142-3015 
3.68m length		EX202-3615 EL142-3615 

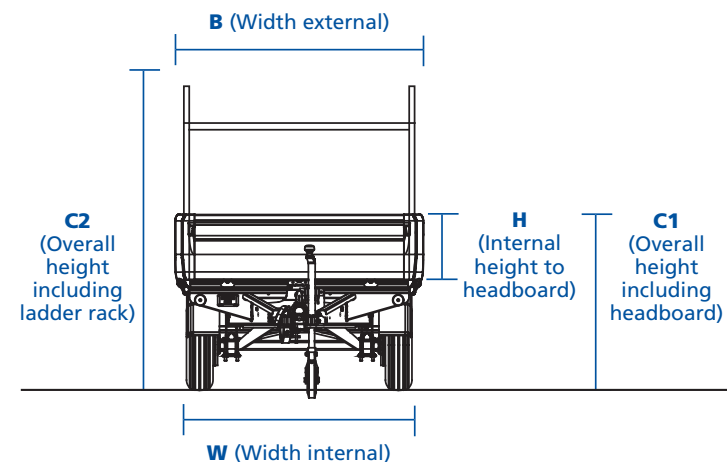
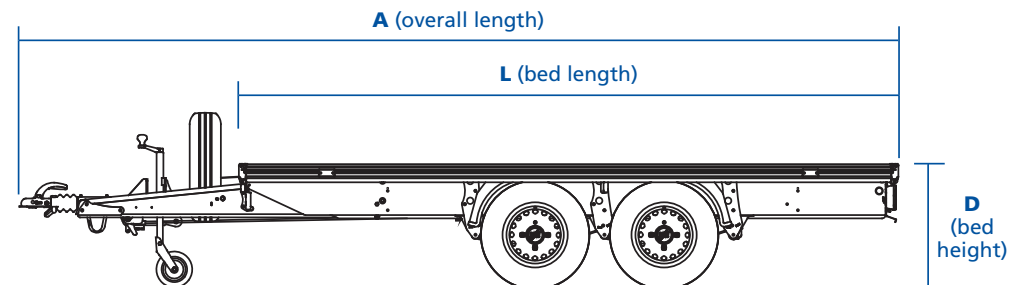

Dimensions in metres	A	B	C1	C2	D	L	W	H	Max Gross weight (kg)	*Unladen weight (kg)
EL101-2012	3.38	1.39	0.99	1.84	0.66	2.08	1.30	0.35	1000	225
EL101-2512	3.91	1.39	0.99	1.84	0.66	2.58	1.30	0.35	1000	247
EL142-2512	3.91	1.39	0.99	1.84	0.66	2.58	1.30	0.35	1400	318
EL101-2515	3.88	1.67	0.99	1.86	0.66	2.58	1.58	0.35	1000	290
EL141-2515	3.88	1.67	0.99	1.86	0.69	2.58	1.58	0.35	1400	296
EL142-2515	3.88	1.67	0.99	1.86	0.66	2.58	1.58	0.35	1400	349
EX202-2515	3.88	1.67	0.99	1.86	0.66	2.58	1.58	0.35	2000	358
EL142-3015	4.38	1.67	0.99	1.86	0.66	3.08	1.58	0.35	1400	368
EX202-3015	4.38	1.67	0.99	1.86	0.66	3.08	1.58	0.35	2000	376
EL142-3615	4.98	1.67	0.99	1.86	0.66	3.68	1.58	0.35	1400	396
EX202-3615	4.98	1.67	0.99	1.86	0.66	3.68	1.58	0.35	2000	403

\*Unladen weight does not include optional extras

# Eurolight Trailers

- Delivery Charge to UK Mainland Distributor
- Trailer Fitted with Resin Coated Plywood Platform
- Aluminium Treadplate Floor Covering
- Removable Aluminium Easy-latch Drop-sides, Tailboard & Headboard\*
- Aluminium Headboard\*
- Removable Steel Headboard, Drop-sides & Tailboard\*
- Removable Steel Headboard\*
- Weldmesh Panelled Side Extensions\* (Drop-sides Required)
- Removable Ladder Rack\* (Headboard Required)
- 2.00m Long Steel Perforated Lockable Loading Skids & Skid Carrier\* (Includes Prop Stands)
- Recessed Lashing Ring (Pair)
- Prop Stands
- Rope Hook Kit (Pair)
- Trailer Aid

## Unbraked Trailers

	Axle	Maximum Gross Weight	Tyres														
EL071-2012	Single	750kg	145/80B10	£65	£660	£120	£420	£150	£190	£70	£245	£40	£180	£20	£55	£8	-
EL071-2512	Single	750kg	145/80B10	£65	£695	£145	£435	£160	£200	£70	£285	£40	£180	£20	£55	£8	-

## Braked Trailers

EL101-2012	Single	1000kg	145/70R13	£65	£805	£120	£420	£150	£190	£70	£245	£40	£180	£20	£55	£8	-
EL101-2512	Single	1000kg	145/70R13	£65	£835	£145	£435	£150	£200	£70	£285	£40	£180	£20	£55	£8	-
EL101-2515	Single	1000kg	145/70R13	£65	£860	£175	£465	£160	£210	£75	£330	£45	£180	£20	£55	£8	-
EL142-2512	Twin	1400kg	145/70R13	£65	£1,110	£145	£435	£150	£200	£70	£285	£40	£180	£20	£55	£8	£31
EL141-2515	Single	1400kg	165/R13C	£65	£930	£175	£465	£160	£210	£75	£330	£45	£180	£20	£55	£8	-
EL142-2515	Twin	1400kg	145/70R13	£65	£1,120	£175	£465	£160	£210	£75	£330	£45	£180	£20	£55	£8	£31
EL142-3015	Twin	1400kg	145/70R13	£65	£1,130	£205	£525	£160	£285	£75	£370	£45	£180	£20	£55	£8	£31
EL142-3615	Twin	1400kg	145/70R13	£65	£1,185	£245	£565	£160	£300	£75	£410	£45	£180	£20	£55	£8	£31
EX202-2515	Twin	2000kg	145/70R13	£65	£1,140	£175	£465	£160	£210	£75	£330	£45	£180	£20	£55	£8	£31
EX202-3015	Twin	2000kg	145/70R13	£65	£1,150	£205	£525	£160	£285	£75	£370	£45	£180	£20	£55	£8	£31
EX202-3615	Twin	2000kg	145/70R13	£65	£1,205	£245	£565	£160	£300	£75	£410	£45	£180	£20	£55	£8	£31

\*Accessories are not factory fitted, an additional charge may be incurred if fitted by a distributor.

Prices are ex-works, exclude fitting and are subject to delivery charges and the VAT rate applicable at the date of supply.

Optional accessories have been priced as factory fit items, ordered with the trailer. If ordered at a later date, your distributor may need to fit the items, which could result in fitting charges being incurred.



### Ifor Williams Trailers Ltd

Cynwyd, Corwen, Denbighshire LL21 0LB UK  
Telephone +44 (0)1490 412527  
Facsimile +44 (0)1490 413216

For further information visit our comprehensive website

[www.iwt.co.uk](http://www.iwt.co.uk)

Dimensions and weights are given as a guide only. We reserve the right to alter specifications without notice.

Distributed throughout the UK & Europe

Product design, descriptions, colours, specifications etc. correct at time of going to press. We constantly strive to improve our products, and from time to time this may result in changes to our range or to individual models. Please check that design, description, colours, specifications described in this brochure are still valid at the time of placing an order.

Our distributors have extensive product knowledge and will be pleased to offer assistance in the selection of your trailer.

© Ifor Williams Trailers Ltd 2009.  
All rights reserved.

No part of this publication may be reproduced in any form or by any means, without the prior written permission of Ifor Williams Trailers Ltd.